

7  
1  
PART: COOLING PLATE  
MAT'L: AL  
QTY: 1

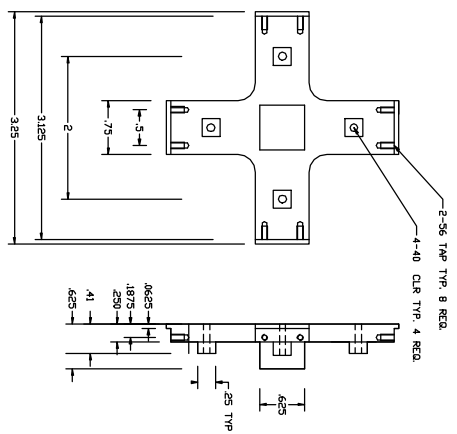

7  
3  
PART: BRACKET  
MAT'L: 1/4 AL BAR STOCK  
QTY: 4 REQ.

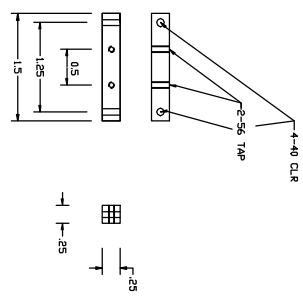

7  
6  
PART: FILTER BRACKET  
MAT'L: P. BRONZE  
QTY: 1 REQ.

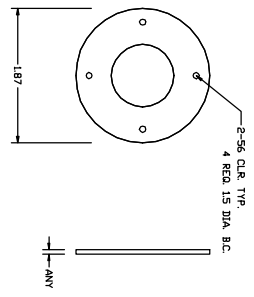

7  
5  
PART: FILTER HOLDER  
MAT'L: AL  
QTY: 1 REQ.

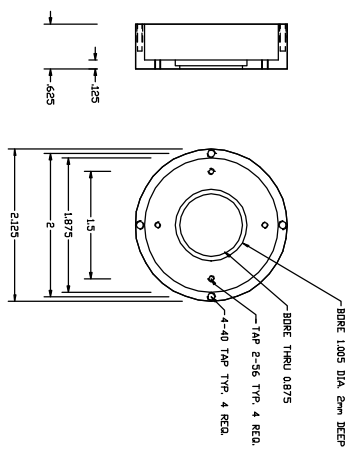

7  
4  
PART: WINDOW RETAINER  
MAT'L: AL  
QTY: 1 REQ.

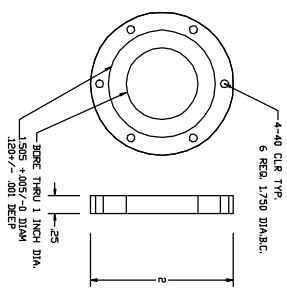

7  
8  
PART: BACK CONNECTOR MOUNT  
MAT'L: BRASS  
QTY: 1 REQ.

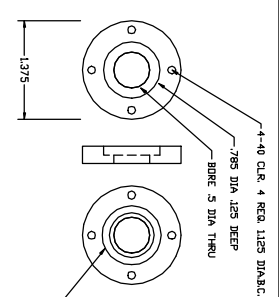

7  
2  
PART: CARD SUPPORTS  
MAT'L: 1/16 G-10  
QTY: 4 REQ.

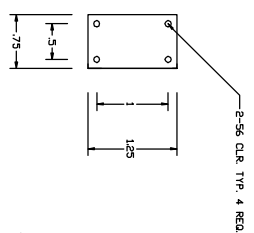

7  
7  
PART: CONNECTOR MOUNT  
MAT'L: BRASS  
QTY: 1 REQ.

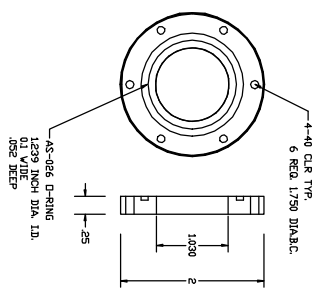

7  
9  
PART: LOW DEWAR MOUNT  
MAT'L: BRASS  
QTY: 1 REQ.

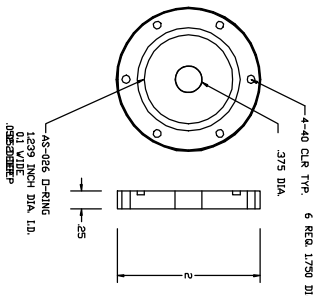

|                                     |             |     |       |
|-------------------------------------|-------------|-----|-------|
| LEUSCHNER OBSERVATORY               |             |     |       |
| UNIVERSITY OF CALIFORNIA - BERKELEY |             |     |       |
| IR CAMERA                           |             |     |       |
| DEWAR                               |             |     |       |
| CARD HOLDER AND OTHER SMALL PARTS   |             |     |       |
| DATE                                | BY          | REV | SCALE |
| 7/23/98                             | R. TREFFERS | 1   | 1:1   |
| SECTION                             | TYPE        | NO  | REV   |
| 3                                   | 3           | 1   | 1     |